

BT9

ASSEMBLY INSTUCTIONS

Getting started:

prepare a protection layer, a screwdriver

STEP 1: Joint side panel with back panel

STEP 2: Joint bottom panel with side panel

STEP 3: Joint side panel with bottom & back panel





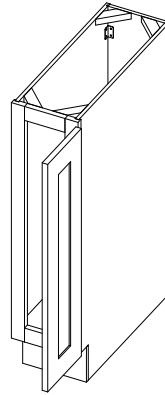

STEP 4: Attach frame on and toekick board

STEP 5: Attach the plastic block on the top corner

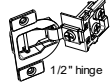
STEP 6: Fix door onto the frame and adjust the cover-space

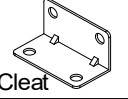
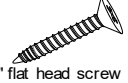
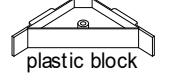

PARTS LIST		
NO.	Description	QTY
A	BACK PANEL	1
B	SIDE PANEL	2
C	TOP&BOTTOM PANEL	1
D	FACE FRAME	1
E	TOE KICK	1
F	CABINETS DOOR	1

8	1/2" HINGE	2	
7	3/4" ROUND HEAD SCREW	2	
6	BUMPER	2	
5	9/16"ROUND HEAD SCREW	40	
4	CLEAT	10	
3	1"FLAT HEAD SCREW FOR CARCASS	2	
2	Plastic Block	4	
1	9/16" flat head screw	8	
NO.	Description	QTY	PICTURE

HARDWARE LIST

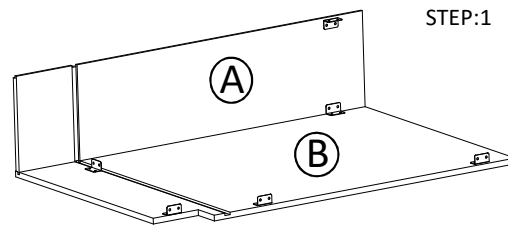

STEP:1

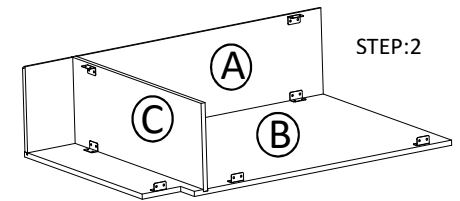

STEP:2

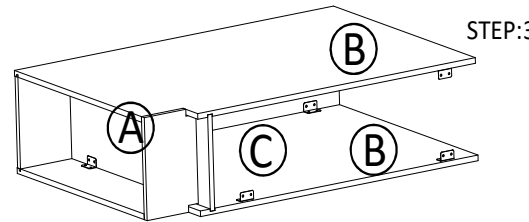

STEP:3

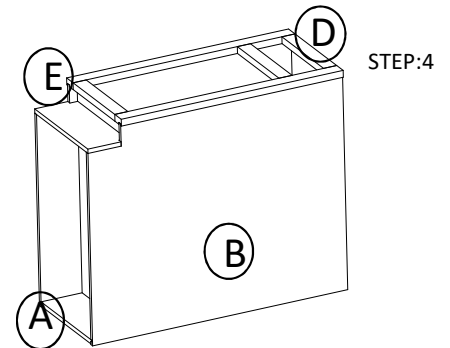

STEP:4

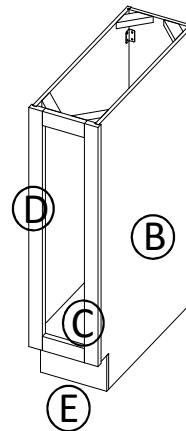

STEP:5

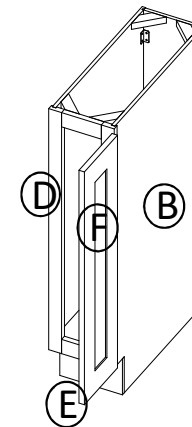

STEP:6