

B12,B15,B18,B21
ASSEMBLY INSTRUCTIONS

Getting started:

prepare a protection layer, a screwdriver

STEP 1: Joint side panel with back panel

STEP 2: Joint bottom panel with side panel

STEP 3: Joint side panel with bottom & back panel

STEP 4: Attach frame on and toekick board









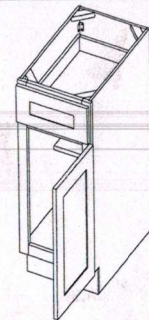

STEP 5: Joint the drawer together, then install the drawer guide.

STEP 6: Attach the wood block on the top corner, and put on the adjustable shelf

STEP 7: Fix drawer head on the drawer front and fix door onto the frame and adjust the cover-space

PARTS LIST		
NO.	Description	QTY
A	BACK PANEL	1
B	SIDE PANEL	2
C	TOP&BOTTOM PANEL	1
D	TOE KICK	1
E	FACE FRAME	1
F	DRAWER BOX FRONT AND BACK	2
G	DRAWER BOX SIDE	2
H	DRAWER BOX BOTTOM	1
I	ADJUSTABLE SHELF	1
J	DRAWER HEAD	1
K	CABINETS DOOR	1



13	HINGE PLATE	1		Hinge Plate
12	1 1/2" SOFTCLOSE HINGE	2		1 1/2" hinge
11	3/4" ROUND HEAD SCREW	2		3/4" round head screw
10	BUMPER	6		Bumper
9	DAMPER	1		Damper
8	1" ROUND HEAD SCREW	4		1" round head screw
7	Selfclose slider	1		Selfclose slider
6	SHELF CLIP	4		Shelf clip
5	9/16" ROUND HEAD SCREW	40		9/16" round head screw
4	CLEAT	10		Cleat
3	1" FLAT HEAD SCREW FOR CARCASS	2		1" flat head screw
2	WOOD BLOCK	4		Wood block
1	1" FLAT HEAD SCREW FOR WOOD BLOCK	8		1" flat head screw
NO.	Description	QTY	PICTURE	
HARDWARE LIST				

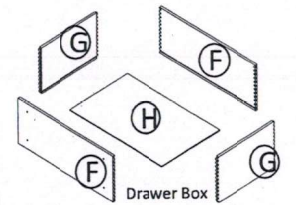
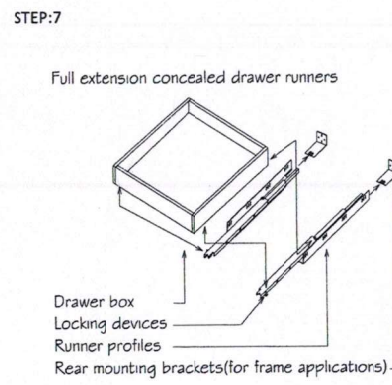
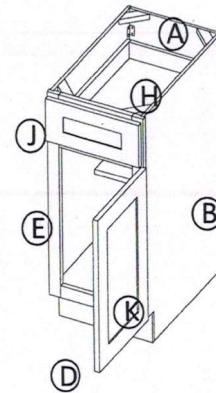
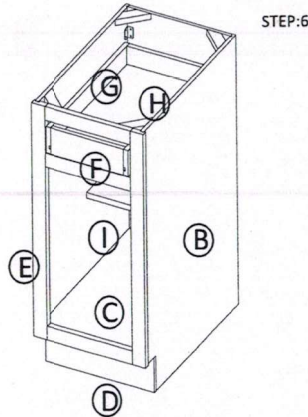
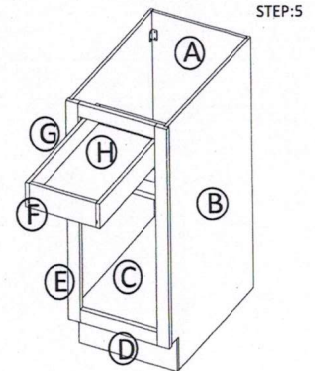
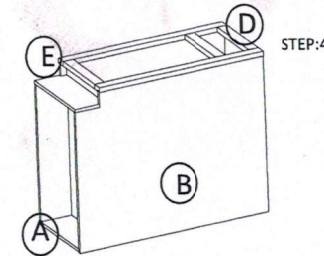
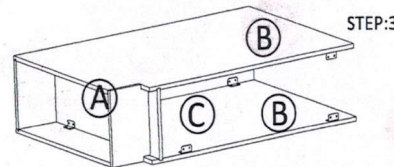
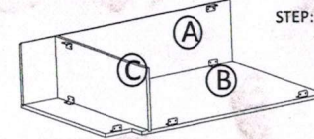
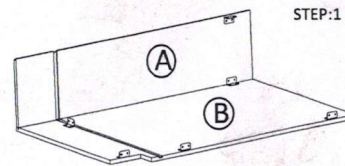

How To Fix Soft Close Hinge

